

alpro

Round Mortice Cylinder Deadlatches

524510 Lock Type

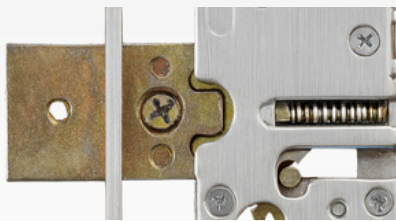
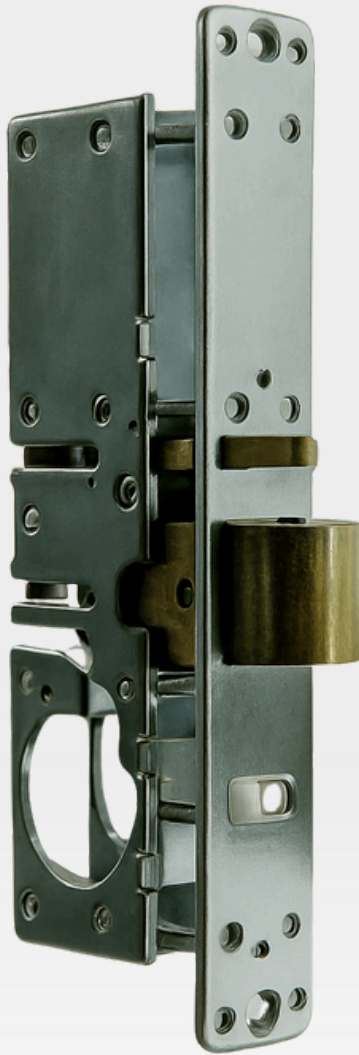

R = Reversible Handing

Deadlatches offer flexible control of situations and can be used in conjunction with electric strikes to provide the added option of remote access control.

Designed to operate on doors with 3mm door gaps, the deadlatches can also be operated with the 459 paddle handle (cam plug required).

Features

- Range of back sets available
- Locks accept standard 37/32" 29.37mm mortice key or thumbturn cylinder
- Faceplate finish SAA
- Industry standard ANSI cut outs
- Europrofile or round mortice cylinder options
- Latch hold back facility
- Latches compatible for use with electric strikes

Instructions for changing or reversing the deadlatch

- Undo & remove the screw in the middle of the deadlatch.
- Remove the deadlatch and reverse its orientation.
- Reattach the deadlatch, insert & tighten the screw.

Round Mortice Cylinder Deadlatches - 524510 Lock Type



3 YEAR GUARANTEE

Ordering Information

Description

Description	Code
Deadlatch to suit round mortice cylinder 1 1/8" back set (RH)	5245101
Deadlatch to suit round mortice cylinder 1 1/8" back set (LH)	5245102
Deadlatch to suit round mortice cylinder 31/32" back set (RH)	5245103
Deadlatch to suit round mortice cylinder 31/32" back set (LH)	5245104
Alpro Deadlatch to suit round mortise cylinder complete with strike plate back set 1 1/2" (R)	5245105
Flat faceplate SAA - width 25mm	52FP4511
Radius faceplate SAA - width 25mm	52FP4512
Radius faceplate with weather strip SAA - width 25mm	52FP4513
Strike plate	5235
Deadlatch fixing kit - width 25mm	5245-FIX-KIT
Extended strike plate	5245ESP

For details of the faceplate variants available, see page Lock Accessories datasheet [link](#).

Imperial Backset	Metric Equivalent	Dimension A
31/32"	24.6 mm	41.4mm
1 1/8"	28.6 mm	45.2mm
1 1/2"	38.1 mm	50 mm

Handing of doors for locks

The description of swinging door operation always viewed from the outside.

LH: Door hinges on left

RH: Door hinges on right

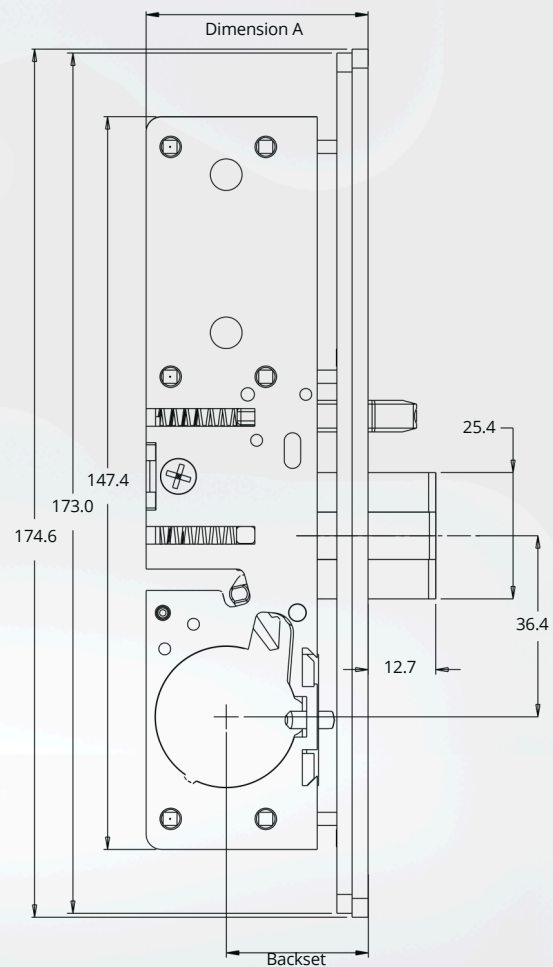
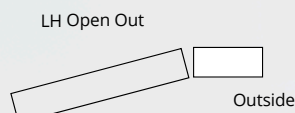
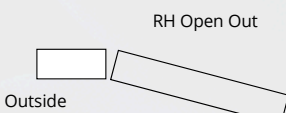
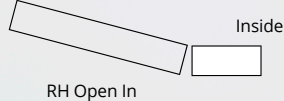
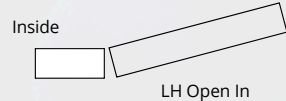

524510 Lock Type

All dimensions are shown in mm.